

<問題1>

次の図形と合同な図形を作図しましょう。

①

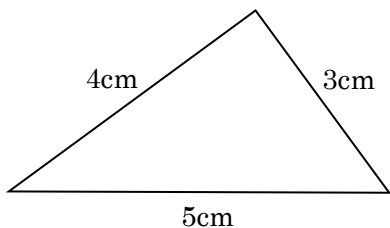

②

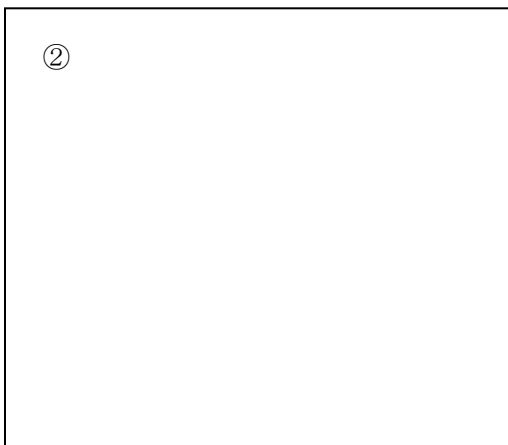
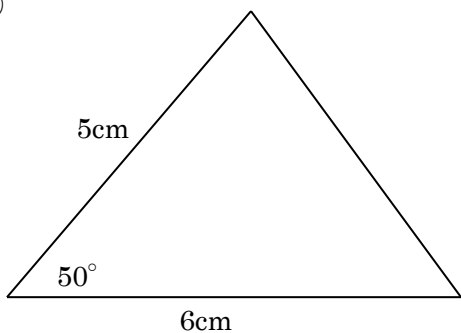

③

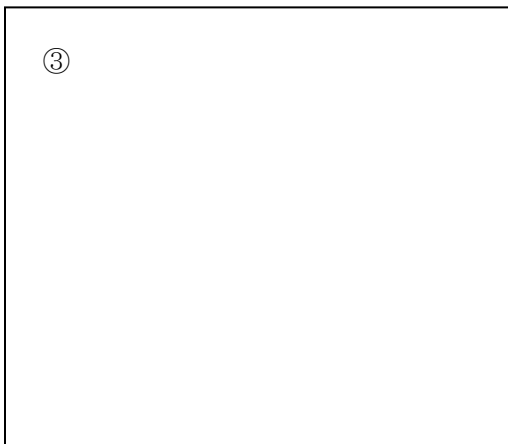
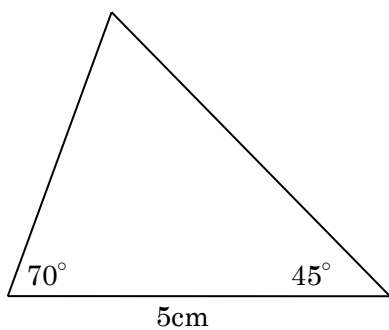

<問題2>

□にあてはまる数を、計算で求めましょう。

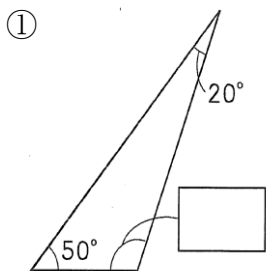

()

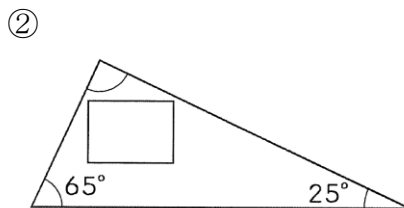

()

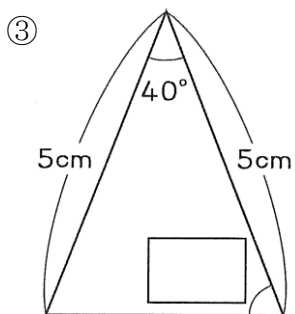

()

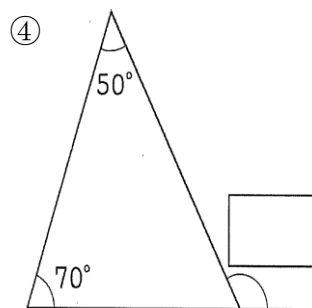

()

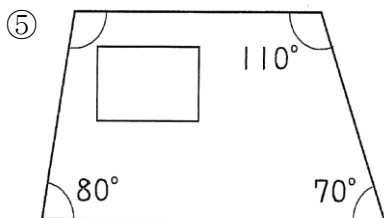

()

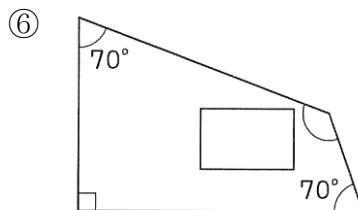

()

大山小5年 5年のまとめ⑤

(

)

<練習問題>

P35、48 ねんおし合同③